

CLARKE®

X-PRO



AIR IMPACT WRENCH

MODEL NO: CAT141 & 142

PART NO: 3120155 / 3120156

OPERATING & MAINTENANCE INSTRUCTIONS

UK
CA | CE

ORIGINAL INSTRUCTIONS

GC02/22 - rev 3

INTRODUCTION

Thank you for purchasing this CLARKE Impact Wrench. The CAT141 and CAT142 are identical wrenches, the CAT142 being supplied in a moulded plastic storage case which contains the following:

- 1 x Mini-Oiler
- 1 x Hex Key
- Oil Bottle
- 1 x Extension Bar
- Snap Connector fitting
- 10 Impact Sockets, (9, 10, 11, 13, 14, 17, 19, 22, 24 & 27mm sizes)

Please read all of the safety and operating instructions carefully before using this product. In doing so you will ensure the safety of yourself and that of others around you, and you can look forward to your purchase giving you long and satisfactory service.

OVERVIEW

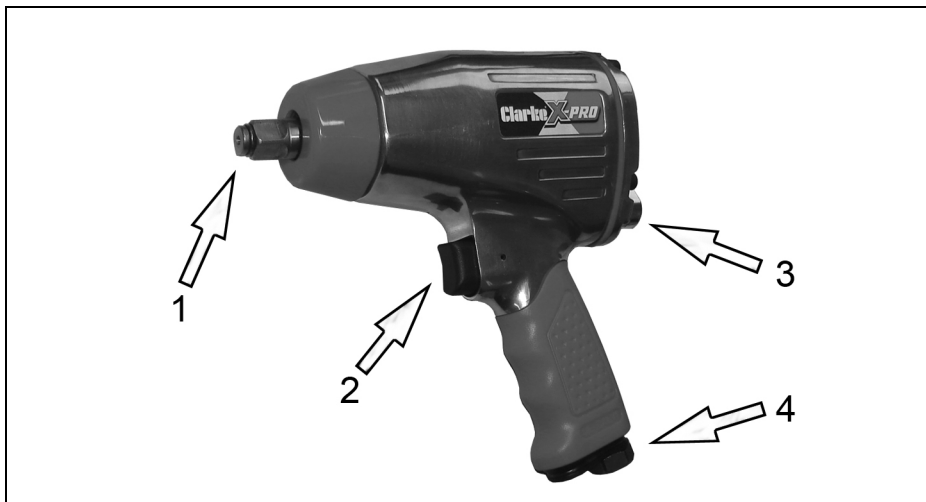

NO	DESCRIPTION	NO	DESCRIPTION
1	Square Drive	3	Direction/Speed Control
2	Trigger	4	Airline Inlet

SPECIFICATION

Model Number	CAT141/CAT142
Part Number(s)	3120155 / 3120156
Min. Hose Size (ID)	1/4" BSP
Max Operating Pressure	90 psi (6.2 bar)
Air Consumption	18 cfm (max @90psi) average 6.5 cfm
Drive size	1/2" Square
Max No Load Speed	7000 rpm @ 90psi
Max Torque	350 ft/lb
Air Inlet Size	1/4" BSP Female
Sound Pressure Level (LpA dB)	87 dB(A)
Sound Power Level (LwA dB)	98 dB(A)
Vibration Levels	4.35 m/s ² (uncertainty factor K= 1.5m/s ²)
Weight(s)	2.2 kg (CAT141)
	4.26 kg complete (CAT142)
Wrench Dimensions (L x W x H)	198 x 190 x 67 mm

Please note that the details and specifications contained herein are correct at the time of going to print. However Clarke International reserve the right to change specifications at any time without prior notice.

GUARANTEE

This product is guaranteed against faulty manufacture for a period of 12 months from the date of purchase. Please keep your receipt which will be required as proof of purchase.

This guarantee is invalid if the product is found to have been abused or tampered with in any way, or not used for the purpose for which it was intended. Faulty goods should be returned to their place of purchase, no product can be returned to us without prior permission.

This guarantee does not effect your statutory rights.

GENERAL SAFETY RULES



CAUTION: FAILURE TO FOLLOW THESE PRECAUTIONS COULD RESULT IN PERSONAL INJURY, AND/OR DAMAGE TO PROPERTY.

WORK ENVIRONMENT

1. Keep the work area clean and tidy.
2. Dress appropriately - Do not wear loose clothing or jewellery. Tie long hair out of the way.
3. Keep children and visitors away - Do not let children handle the tool.
4. Do not operate the tool where there are flammable liquids or gases.

USE OF POWER TOOLS

1. Stay alert and use common sense - do not operate the tool when you are tired or under the influence of alcohol, drugs or medication.
2. Always wear eye protectors when using the tool. Eye protectors must provide protection from flying particles from the front and the side. Ear protectors should also be worn.
3. Do not overreach - Keep proper footing and balance at all times.
4. Never use oxygen, CO², combustible gases or any type of bottled gas as a source of power for this tool.
5. Do not connect the air supply hose with your finger on the trigger.
6. Do not exceed the maximum pressure for the tool of 90 psi / 6.2 bar.
7. Keep the air supply hose away from heat, oil and sharp edges.
8. Do not fit the tool to any stand or clamping device that may damage it.
9. Check hoses for leaks or worn condition before use, and ensure that all connections are secure.
10. Do not use the tool for any purpose than that described in this manual.
11. Do not carry out any alterations or modifications to the tool.
12. Always disconnect from the air supply when:
 - Performing any maintenance.
 - The tool is not in use.
 - The tool will be left unattended.

- Moving to another work area.
 - Passing the tool to another person.
13. Never use the tool if it is defective or operating abnormally.
 14. This tool should be serviced at regular intervals by qualified personnel.
 15. Avoid damaging the tool for example by applying excessive force of any kind.
 16. Always maintain the tool with care. Keep it clean for the best and safest performance.
 17. Quick change couplings should not be located at the tool. They add weight and could fail due to vibration.
 18. Do not force or misuse the tool. It will do a better and safer job at the rate for which it was designed.
 19. Do not remove any labels. Damaged labels should be replaced.
 20. This tool vibrates with use. Vibration may be harmful to your hands or arms. Stop using the tool if discomfort, a tingling feeling or pain occurs. Seek medical advice before resuming use.

IMPACT WRENCH SAFETY INSTRUCTIONS

1. Always use the impact wrench in the manner and for the functions described in these instructions.
2. Always ensure the wrench is not moving and disconnected from the air supply when changing sockets etc. Use only Impact Wrench sockets....DO NOT use standard sockets.
3. Always finish tightening wheel nuts or engine parts with a torque wrench or suitable spanner to the correct torque as recommended by the vehicle manufacturer.
4. Always avoid excessive use of the impact wrench. When tightening a nut or bolt, never allow the wrench to impact more than 8 times - to avoid over tightening - 3 to 4 impacts is normally sufficient.
5. Always ensure that the socket is correctly installed before switching on.
6. Always only use sockets which are specified for impact wrench use.
7. Due to the possible presence of asbestos dust from brake linings, always wear suitable respiratory protection.
8. Never carry the impact wrench by the air supply hose.
9. Always disconnect from the air supply when changing sockets or when the wrench is not required for immediate use in order to avoid accidental starting.



10. Always store this product in a dry, secure place out of reach of children or untrained users.
11. Always use both hands to control the impact wrench.
12. Always ensure the wrench has stopped before putting it down after use.

TRANSPORT & STORAGE

1. Never carry the tool by the air hose.
2. Never carry the tool with your finger on the trigger.
3. When not in use the tool must be disconnected from the air supply and stored in a dry place out of the reach of children (preferably in a locked cabinet).
4. Avoid storing the tool where the temperature is below 0°C.

SAFETY SYMBOLS

The following safety symbols are to be found on the tool.

	<p>Read this instruction booklet carefully before use.</p>		<p>Wear ear protection.</p>
	<p>Wear eye protection.</p>		

Please keep these instructions in a safe place for future reference.

COMPRESSED AIR REQUIREMENTS



WARNING: COMPRESSED AIR CAN BE DANGEROUS. ENSURE THAT YOU ARE FAMILIAR WITH ALL PRECAUTIONS RELATING TO THE USE OF COMPRESSORS AND COMPRESSED AIR SUPPLY.

- A typical air line layout is shown below.

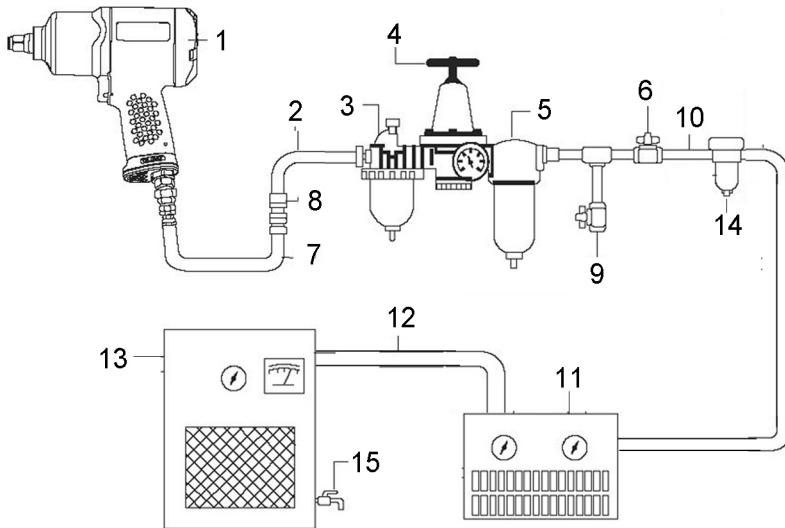

AIR SYSTEM LAYOUT :

- | | |
|-------------------------------|-------------------------------------|
| 1. Air Tool | 9. Drain Valve |
| 2. Air Hose 3/8" (I.D.) | 10. 1/2" or larger pipe and fitting |
| 3. Oiler | 11. Air Dryer |
| 4. Pressure Regulator | 12. 1" or larger pipe and fitting |
| 5. Filter | 13. Air Compressor |
| 6. Shut Off Valve | 14. Auto Drain |
| 7. Whip Hose | 15. Drain Valve |
| 8. Coupler Body And Connector | |

- Use only clean, dry, regulated compressed air as a power source.
- Air compressors used with the tool must comply with the appropriate European Community Safety Directives.

- A build-up of moisture or oil in the air compressor will accelerate wear and corrosion in the tool. Ensure any moisture is drained from the compressor daily and the inlet filter is kept clean.
- If an unusually long air hose is required, (over 8 metres), the line pressure or the hose inside diameter may need to be increased.
- The air hose must be rated at least 150% of the maximum operating pressure of the tool.
- If an automatic in-line filter/regulator is used, it will keep the tool in good condition, but should be regularly checked and topped up with oil. Clarke airline oil should be used, and the lubricator adjusted to approx 2 drops per minute.
- For optimum performance it is recommended that a 3/8" ID hose is used.
- Never exceed the maximum operating pressure for the tool. It is recommended that air pressure to this tool does not exceed 90 psi at the tool when running. Higher pressures and dirty air will shorten the life of the tool due to faster wear and is a possible safety hazard.

CONNECTING THE AIRLINE

NOTE: Ensure the compressor is turned off.

1. If required, connect an in-line mini oiler to the tool.

- A mini oiler helps to prolong the life of the impact wrench.

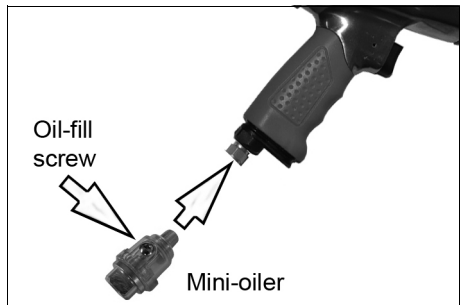

2. If a mini-oiler is not being used, run a few drops of oil through the tool before use. It can be entered through the airline connector or via the hose at the nearest connection to the air supply.

3. Connect a suitable hose as shown.
4. Connect the other end of the hose to the compressor.



5. Turn on the air supply and check for air leaks. Rectify any found before proceeding.

- PTFE tape may be useful for sealing threaded connections.

Your air tool is now ready for use.

You can fit a whip hose with a quick fit coupling if required, available from your Clarke dealer.

OPERATION

FITTING THE IMPACT SOCKET



WARNING: NEVER USE STANDARD SOCKETS. THESE MAY SHATTER WITH SERIOUS CONSEQUENCES. ONLY USE IMPACT SOCKETS DESIGNED FOR USE WITH IMPACT TOOLS.

1. Select the impact socket you require, which must be in good condition and fit the tool exactly.
2. Push the socket onto the square drive shaft as shown.

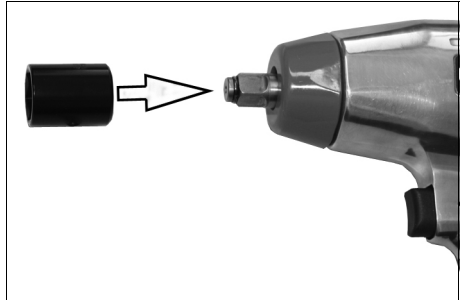

OPERATING THE IMPACT WRENCH

1. Locate the socket over the nut to be tightened or loosened.
2. Squeeze the trigger to start the wrench.
3. Release the trigger switch to stop the wrench.
 - The anvil will continue to rotate very briefly after the trigger has been released.



ADJUSTING THE POWER

1. To adjust the power, set the tool to one of the 3 settings available. (Setting 1-Low, 3 -High)
 - These numbers are only for reference and do not denote a specific amount of power.

For maximum power when removing stubborn nuts, turn the impact wrench to its highest setting.

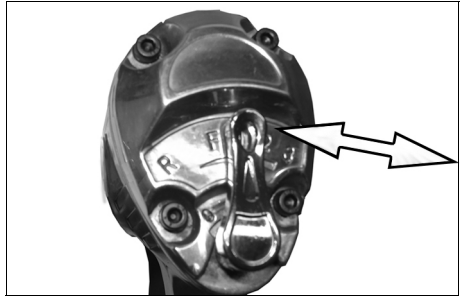

SELECTING FORWARD/REVERSE



WARNING: WAIT UNTIL THE ANVIL HAS STOPPED ROTATING BEFORE OPERATING THE FORWARD/REVERSE BUTTON.

Forward/Reverse rotation is selected by pushing the combined Forward/Reverse knob/power regulator in the direction shown by the arrow on the back of the wrench.

1. For normal tightening, the wrench should be operated in the forward (F) direction at position 1, 2 or 3.
2. For loosening, the wrench should be operated in the reverse (R) direction.

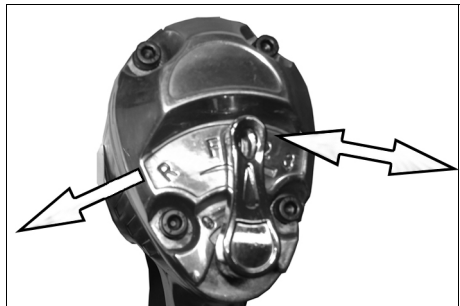

DISCONNECTING THE AIR SUPPLY

1. Do not disconnect the air supply hose until the compressor has been shut down and the compressed air released.
2. Refer to the compressor instruction manual for the procedure to shut down and vent the compressed air.
3. Once the pressure has been released, disconnect the air supply hose from the air tool.

MAINTENANCE



WARNING: MAKE SURE THAT THE AIR TOOL IS DISCONNECTED FROM THE AIR SUPPLY BEFORE STARTING ANY CLEANING, OR MAINTENANCE PROCEDURES.

DAILY

1. Before use, drain water from the airline filter and compressor.
2. Pour a few drops of Clarke air-line oil, into the tool air inlet. This should be carried out regardless of whether or not an in-line mini oiler is used. If an in-line mini oiler is not used, this procedure should be repeated after every two to three hours of use, or at the start of the working day.
3. Keep the body of the tool clean and free from debris.

WEEKLY

1. Check the air inlet screen filter for blockage & clean out if required.

CLEANING & STORAGE

1. Grit or gum deposits in the tool may reduce efficiency and cause the tool to run erratically. This condition can be corrected by cleaning the air strainer and flushing out the tool with gum solvent oil.
2. Failing this, the tool should be disassembled, thoroughly cleaned, dried and reassembled.
3. The tool may be dismantled by removing the rear cover using the hex key supplied prior to replacing any worn or damaged parts. You may prefer to take the tool to your Clarke dealer if internal maintenance is required.
4. While is a dismantled state, it may be desirable to grease the hammer mechanism and applying a small amount of good quality bearing grease.
 - This may be better left to your Clarke dealer.
 - A hex key is provided for removing the end cover from the wrench.
5. If the tool is to be stored, or is idle for longer than 24 hours, run a few drops of Clarke air line oil into the air inlet and run the tool for 5 seconds to lubricate the internal parts. Store in its box in a dry, secure environment.

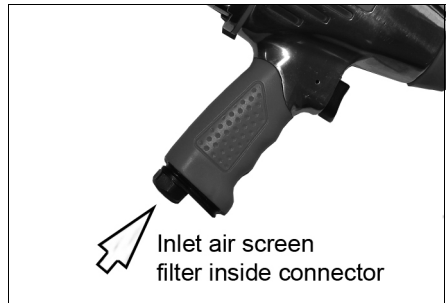

TROUBLESHOOTING

SYMPTOM	PROBLEM	SOLUTION
Tool runs at normal speed but slows down under any load.	<ol style="list-style-type: none"> 1. Motor parts worn. 2. Worn or sticking mechanism due to lack of lubricant. 	<ol style="list-style-type: none"> 1. Return to Clarke dealer for repair. 2. Drip air tool lubricating oil into air inlet. Allow oil to soak moving parts before using.
Tool runs slowly. Air flows weakly from exhaust.	<ol style="list-style-type: none"> 1. Motor parts jammed with gum/dirt. 2. Air-line regulator in closed position. 3. General airflow blocked by dirt. 	<ol style="list-style-type: none"> 1. Examine inlet air filter for blockage. Drip a few drops of air tool lubricating oil into air inlet. 2. Adjust in-line regulator to open position. 3. Operate tool in short bursts.
Tool will not run. Air flows freely from exhaust.	<ol style="list-style-type: none"> 1. Motor vanes stuck due to buildup of foreign material. 	<ol style="list-style-type: none"> 1. Disconnect air supply and rotate tool assembly manually. 2. Try operating tool in short bursts. 3. Tap motor housing gently with a rubber mallet. 4. Drip a few drops of air tool lubricating oil into air inlet to soak moving parts.
Tool will not shut off.	<ol style="list-style-type: none"> 1. Throttle O-rings damaged or ill-fitting in seat. 	<ol style="list-style-type: none"> 1. Return to Clarke dealer for repair.

PERFORMANCE

Please note that factors other than the tool may effect its operation and efficiency such as reduced compressor output, excessive drain on the airline, moisture or restrictions in the air-line, or the use of connectors of improper size or poor condition which will reduce air supply.

**Clarke Air Line Oil (part no. 3050825) is available from your Clarke dealer.

Your Clarke air tool has been designed to give long and trouble free service. If, however, having followed the instructions in this booklet carefully, you encounter problems, take the unit to your local Clarke dealer.

PARTS LIST

No	Description
1	Main Housing
2	Nose Bushing
3	Square Drive
4	Hammer Cage
5	Hammer
6	Hammer Pin
7	Bearing
8	Oil Seal
9	Front Plate
10	Set Pin
11	Cylinder
12	Set Pin
13	Rotor
14	Rotor Blade
15	Rear Plate
16	Gasket
17	Ringpiece
18	Rear Cover
19	Washer
20	Socket headed Screw

No	Description
21	Trigger
22	Spring
23	Trigger Sleeve
24	Roll Pin
25	Valve Sleeve
26	Valve Stem
27	Spacer
28	Bolt
29	Set Pin
30	Spring
31	Forward/Reverse Switch
32	Oil Seal
33	Pin
34	Pin Cover
35	Spring
36	O-Ring
37	Exhaust Deflector
38	Cushion
39	Air Inlet
40	Soft Grip

ACCESSORIES

A wide range of accessories is available including filter/regulators, lubricators, high-pressure hoses (5 to 50 metres) etc.

Contact your Clarke dealer for further information or the Clarke International Service Department.

PARTS DIAGRAM

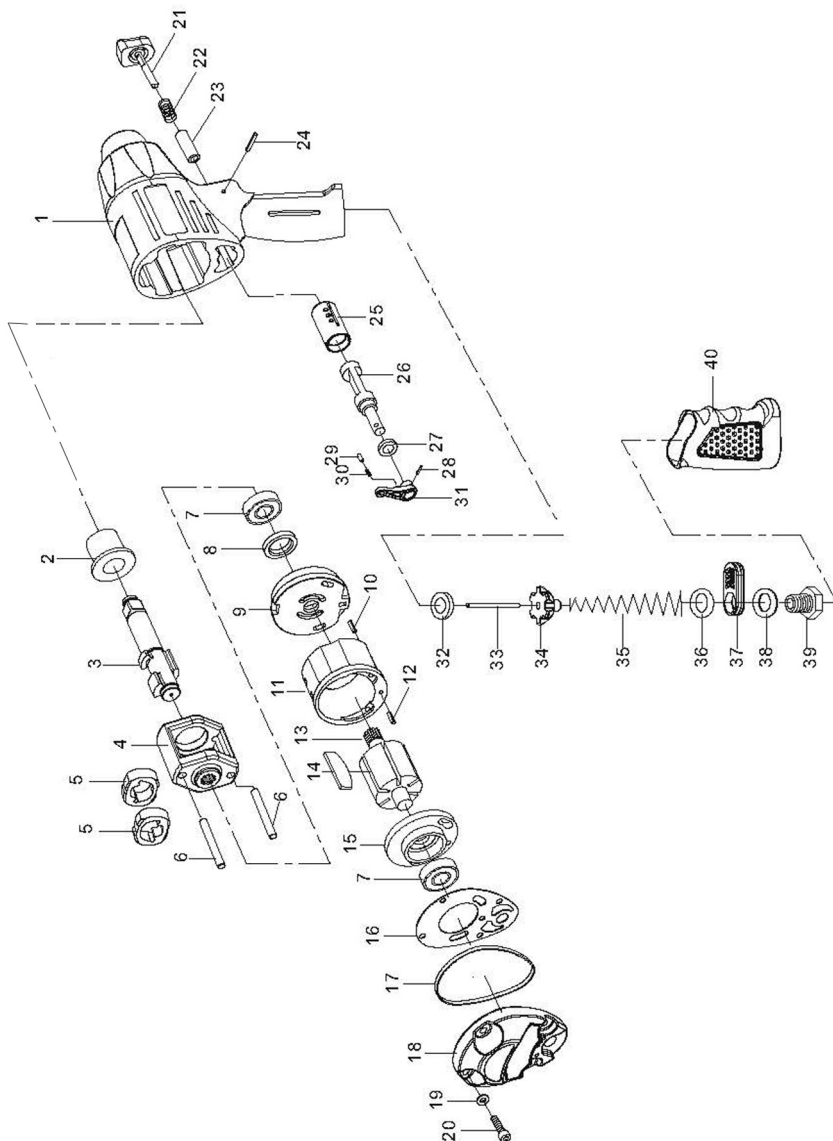

DECLARATION OF CONFORMITY



Fitzwilliam Hall, Fitzwilliam Place, Dublin 2

DECLARATION OF CONFORMITY

This is an important document and should be retained.

We hereby declare that this product(s) complies with the following directive(s):
2006/42/EC Machinery Directive.

The following standards have been applied to the product(s):
EN ISO 11148-6:2012

The technical documentation required to demonstrate that the product(s) meet(s) the requirements of the aforementioned directive(s) has been compiled and is available for inspection by the relevant enforcement authorities.

The CE mark was first applied in: 2013

Product Description: Air Impact Wrench
Model number(s): CAT131, CAT132, CAT141, CAT142
Serial / batch Number: N/A
Date of issue: 09/02/2022

Signed:

J.A. Clarke
Director

CAT142 CE Clarke DOC 020922
CAT141 CE Clarke DOC 020922

Page 1 of 1



Hemnal Street, Epping, Essex, CM16 4UG

DECLARATION OF CONFORMITY

This is an important document and should be retained.

We hereby declare that this product(s) complies with the following statutory requirement(s):
Supply of Machinery (Safety) Regulations 2008

The following standards have been applied to the product(s):
BS EN / ISO 11148-6:2012

The technical documentation required to demonstrate that the product(s) meet(s) the requirements of the aforementioned legislation has been compiled and is available for inspection by the relevant enforcement authorities.

The UKCA mark was first applied in: 2022

Product Description: Air Impact Wrench
Model number(s): CAT131, CAT132, CAT141, CAT142
Serial / batch Number: N/A
Date of issue: 09/02/2022

Signed:

J.A. Clarke
Director

CAT142 UKCA Clarke DOC 020922
CAT141 UKCA Clarke DOC 020922

Page 1 of 1

A SELECTION FROM THE VAST RANGE OF

Clarke®

QUALITY PRODUCTS



AIR COMPRESSORS

From DIY to industrial, Plus air tools, spray guns and accessories.

GENERATORS

Prime duty or emergency standby for business, home and leisure.

POWER WASHERS

Hot and cold, electric and engine driven - we have what you need

WELDERS

Mig, Arc, Tig and Spot.
From DIY to auto/industrial.

METALWORKING

Drills, grinders and saws for DIY and professional use.

WOODWORKING

Saws, sanders, lathes, mortisers and dust extraction.

HYDRAULICS

Cranes, body repair kits, transmission jacks for all types of workshop use.

WATER PUMPS

Submersible, electric and engine driven for DIY, agriculture and industry.

POWER TOOLS

Angle grinders, cordless drill sets, saws and sanders.

STARTERS/CHARGERS

All sizes for car and commercial use.



PARTS & SERVICE: 0208 988 7400

Parts Enquiries
Parts@clarkeinternational.com

Servicing & Technical Enquiries
Service@clarkeinternational.com

SALES: UK 01992 565333 or Export 00 44 (0)1992 565335

Clarke INTERNATIONAL Hemnall Street, Epping, Essex CM16 4LG
www.clarkeinternational.com